



S60

Extended range of standard "One for All" photoelectric compact sensors

- Complete range of optic functions, basic, advanced and laser class 1
- Models with coaxial optics for polarized retroreflective, contrast and luminescence sensors
- Trimmer or EASY touch™ setting with
- Remote, Keylock and Delay functions
- Standard cable or M12 connection with standard NPN or PNP configuration

APPLICATIONS

- Automatic machines
- Packaging lines
- Transportation lines
- Automatic warehouses
- Pharma and bottling



SENSORS

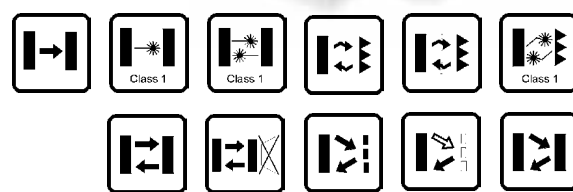

S60		
Through beam		0...20 m 0...60 m (class 1 LASER)
Polarized retroreflective (on R5 reflector)		0.1...8 m 0.1...20 m (class 1 LASER)
Polarized retroreflective coaxial (on R5 reflector)		0...4 m
Polarized retroreflective coaxial transparent (on R5 reflector)		0...2 m
Diffuse proximity		0...100 cm 0...200 cm (long range) 0...60 cm (class 1 LASER)
Background suppression		7...20 cm 5...10 cm (class 1 LASER)
Contrast Sensor		19 mm ±2 mm (white emission)
Luminescence Sensor		0...40 mm
Power supply	Vdc	10...30 V 18...30 V
	Vac	
	Vac/dc	
Output	PNP	▪
	NPN	▪
	NPN/PNP	
	relay	
	other	
Connection	cable	▪
	connector	▪
	pig-tail	
Approximate dimensions (mm)		50x50x15 mm
Housing material		ABS
Mechanical protection		IP67

TECHNICAL DATA	
Power supply	10 ... 30 Vdc
Ripple	≤ 2 Vpp max.
Consumption (output current excluded)	≤ 40 mA max.
Light emission	red LED 660 nm (mod. S60...B01/B51/T51/C01) IR LED 880 nm (mod. S60...C11/G00) white LED 400-700 nm (mod. S60...W08) UV LED 370 nm (mod. S60...U08) red Laser 650 nm (mod. S60...G00/B01/C01/M08)
Setting	sensitivity trimmer (mod. B01/B51/C01/C11/F01/T51)
Operating mode	LIGHT mode on N.O. output / DARK mode on N.C. output (mod.S60...C01/C11/M08/U08) DARK mode on N.O. output / LIGHT mode on N.C. output (mod.S60...B01/B51/F01/T51) LIGHT mode on N.O. output / remote input (mod.M08/W08/U08)
Indicators	yellow OUTPUT LED (S60 all models excluded G00) green STABILITY LED (mod. S60...F01/B01/B51/T51/C01/C11) POWER LED (mod. S60 LASER...F01/B01/C01) green/red READY/ERROR LED (mod. S60...M08/W08/U08)
Output	PNP or NPN; NO; NC (mod. S60)
Output current	100 mA max.
Saturation voltage	2 V max.
Response time	0,5 ms (mod. S60...A00/B01/T01/C10/C21/C01/D00/E01/U08) 2 ms (mod. S60...F01/G00) 1 ms (mod. S50...M08, A00/B01/C01/C10/G00) 4 ms (mod. S60) 100 µs (mod. S60...W08) 333 µs (Laser mod. S60)
Switching frequency	1 kHz (mod. S60...A00/B01/T01/C10/C21/C01/D00/E01/U08) 250 Hz (mod. S50...F01/G00) 500 Hz (mod. S60...M08, A00/B01/C01/C10/G00) 5 kHz (mod. S60...W08) 1,5 kHz (Laser mod. S60)
Connection	2 m Ø 4 mm cable / M12 4-pole connector
Dielectric strength	500 VAC, 1 min between electronic parts and housing
Insulating resistance	>20 MΩ, 500 VDC between electronic parts and housing
Electrical protection	Class 2
Mechanical protection	IP67
Ambient light rejection	according to EN 60947-5-2
Vibrations	0,5 mm amplitude, 10 ... 55 Hz frequency, for every axis (EN60068-2-6)
Shock resistance	11 ms (30 G) 6 shock for every axis (EN60068-2-27)
Housing material	ABS
Lens material	window in PMMA, lenses in glass and polycarbonate
Operating temperature	-10 ... 50 °C (Laser Models) -25 ... 55 °C (LED Models)
Storage temperature	-25 ... 70 °C
Weight	90 g. max. cable vers. / 40 g. max. connector vers.

DIMENSIONS

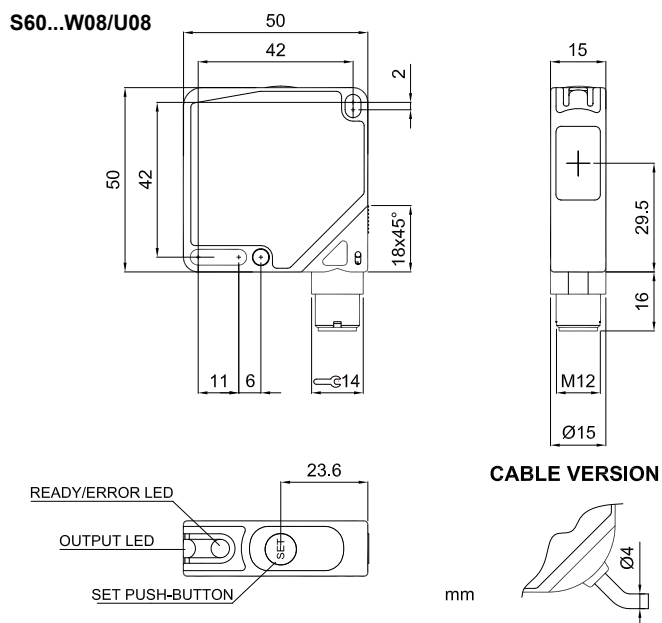
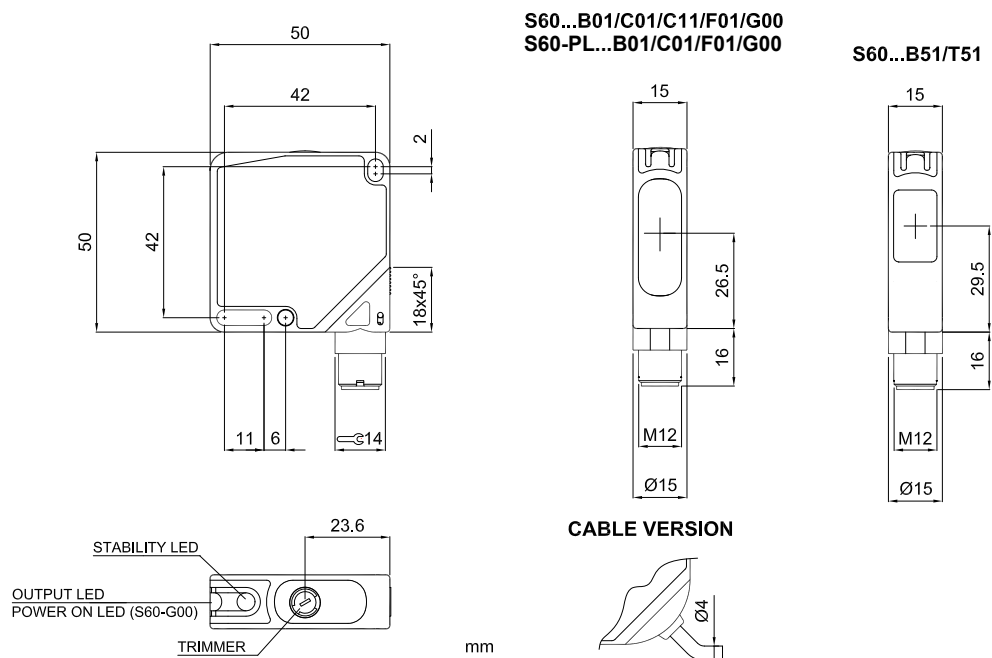

S60...M08

S60-PL...M08

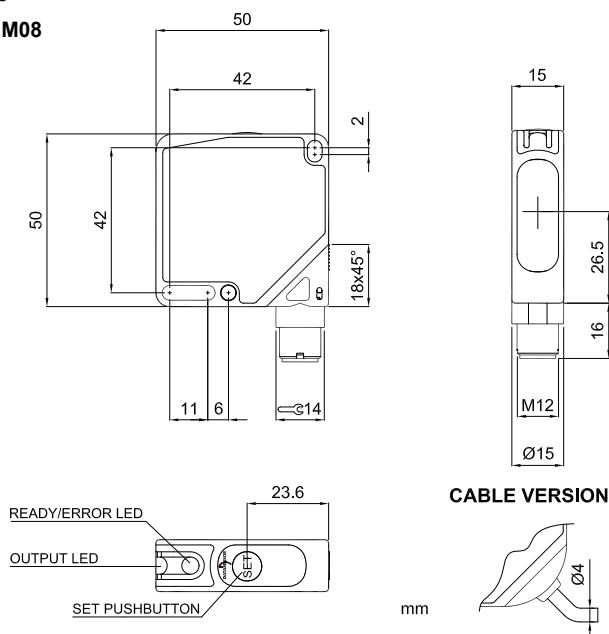

CONNECTIONS



S60-PA-2

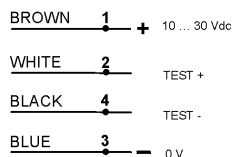

S60-PA-5

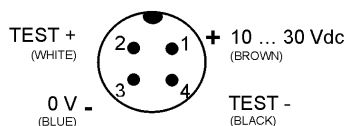

S60...G00
S60-PL...G00

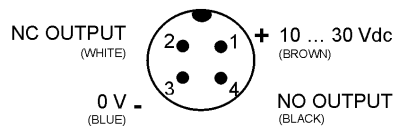
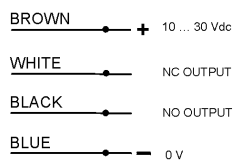

S60...B01,B51,C01,C11,T51,F01
S60-PL...B01,C01,F01

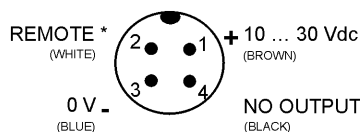
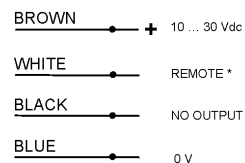

S60...W08,U08,M08
S60-PL...M08

INDICATORS AND SETTINGS

INFRARED EMISSION G00 – LASER RED EMISSION G00/F01



RECEIVER



EMITTER



- A** Output status and stability LEDs (receiver); power on LED (emitter)
- B** Adjustment trimmer (receiver)
- C** M12 connector output
- D** Cable output

Single-turn trimmer for sensitivity adjustment.
 Rotate clockwise direction to increase the operating distance. Decrease sensitivity to increase resolution. Only for Receiver model

B01/B51/T51/C01/C11



A

- A** Output status yellow LED and green Stability LED
- B** Adjustment trimmer
- C** M12 connector output
- D** Cable output

Single-turn trimmer for sensitivity adjustment.
 Rotate clockwise to increase the operating distance.

RED LASER MODEL B01/C01



- A** Output status yellow LED and green Power LED
- B** Teach-in push-button
- C** M12 connector output
- D** Cable output

Single-turn trimmer for sensitivity adjustment.
 Rotate clockwise to increase the operating distance.

W08/U08/M08/M08 LASER



- A** Output status and READY/ERROR LEDs
- B** Teach-in push-button
- C** M12 connector output orientable in two positions
- D** Cable output

Teach-in button for setting.
 EASYtouch™ provides two setting modes: standard or fine.
 Please refer to instructions manual for operating details.

DETECTION DIAGRAMS

S60...F01,G00

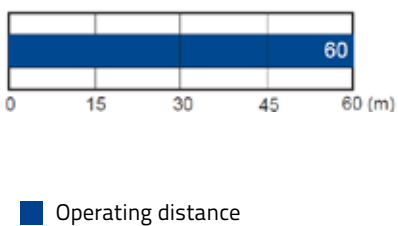
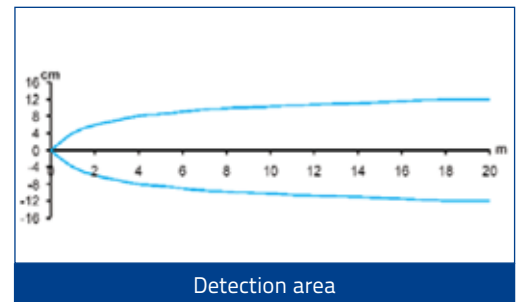
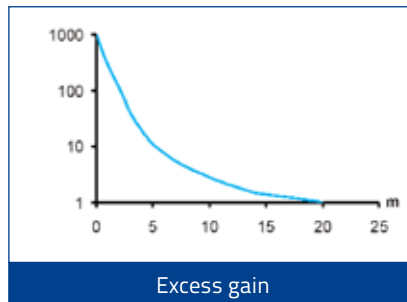
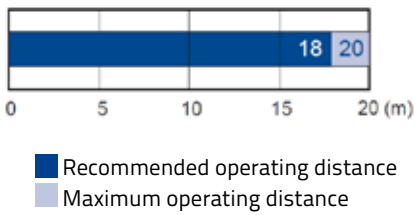

S60-PL...F01,G00

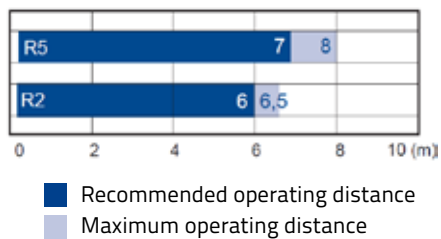
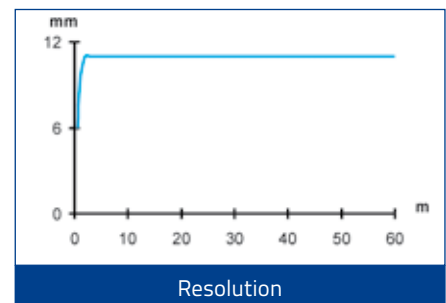
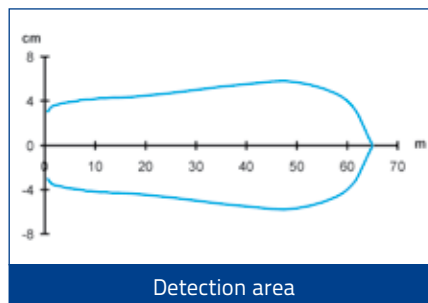

S60...B01

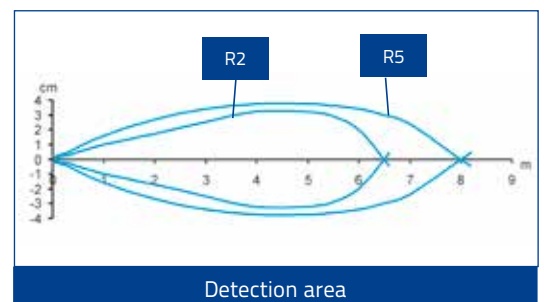
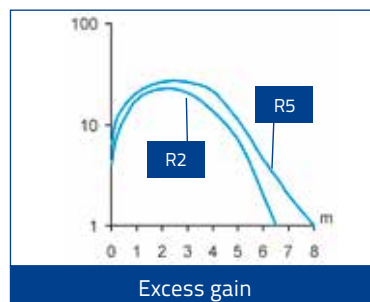

High efficiency reflectors can be used to obtain larger operating distances. Refer to **Reflectors (A.01)** of the **General Catalogue**.

S60-PL...B01

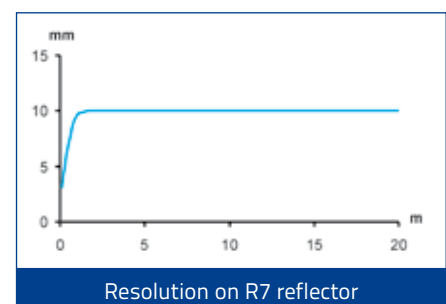
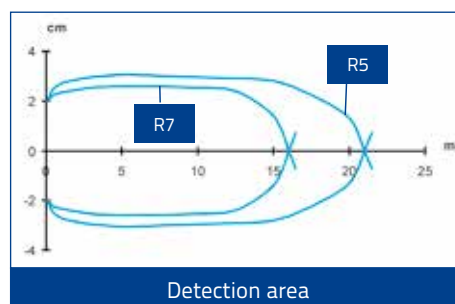
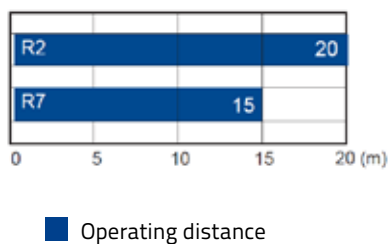

High efficiency reflectors can be used to obtain larger operating distances. Refer to **Reflectors (A.01)** of the **General Catalogue**.

S60...B51

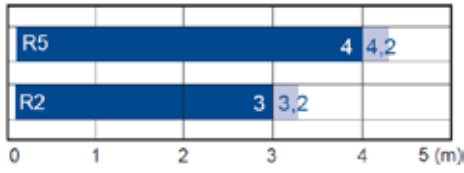

Recommended operating distance
 Maximum operating distance

High efficiency reflectors can be used to obtain larger operating distances. Refer to **Reflectors**.

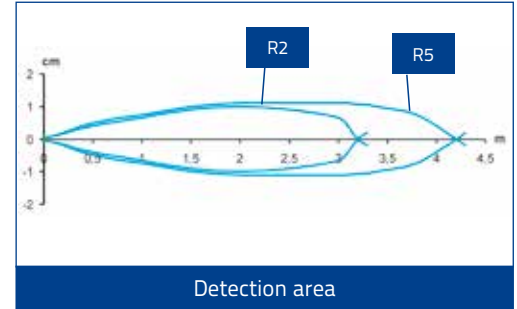
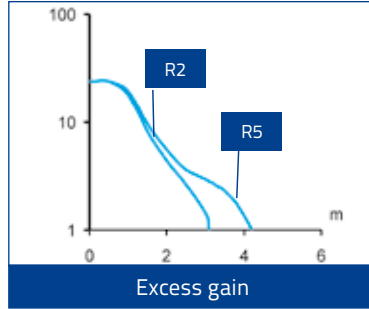

S60...T51

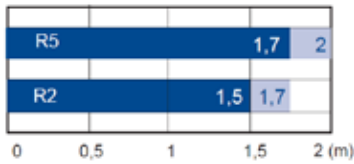

Recommended operating distance
 Maximum operating distance

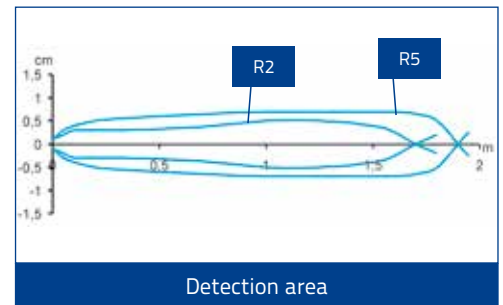
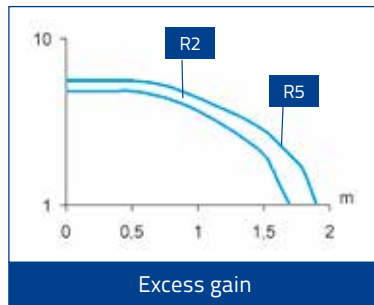

S60...C01

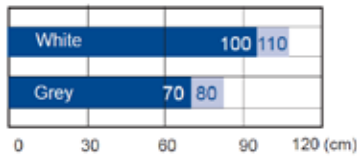

Recommended operating distance
 Maximum operating distance

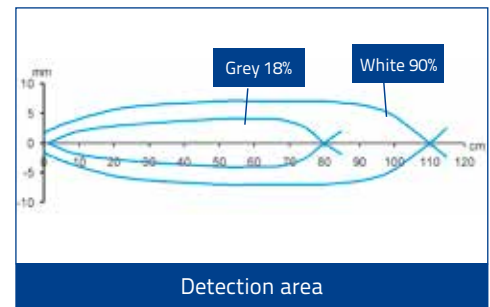
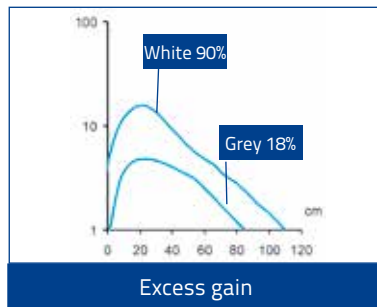

S60...C11

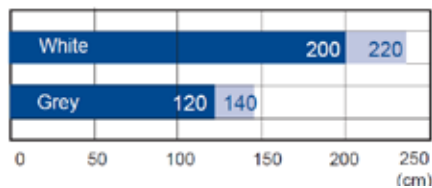

Recommended operating distance
 Maximum operating distance

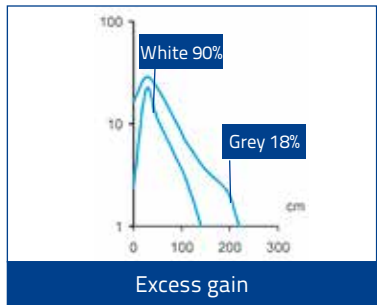

S60-PL...C01

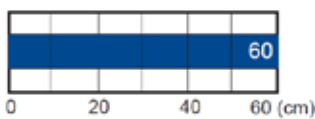

Operating distance

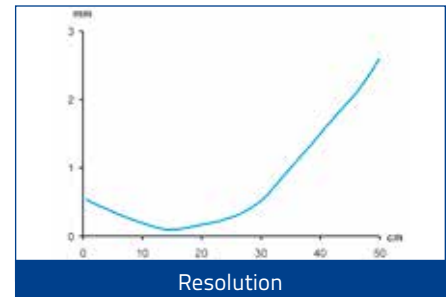
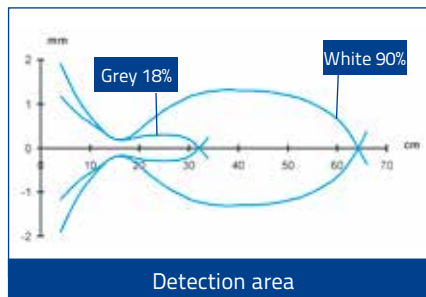

S60...M08

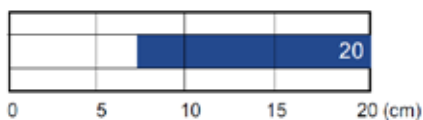

■ Operating distance

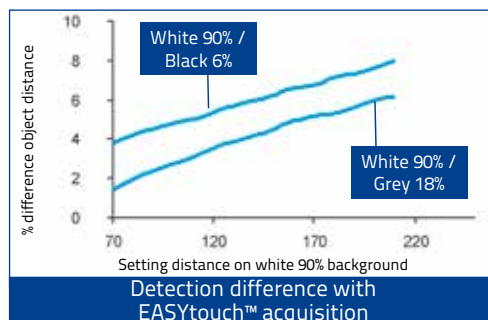

S60-PL...M08

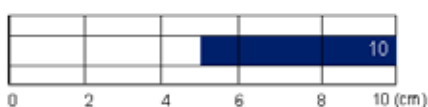

■ Operating distance

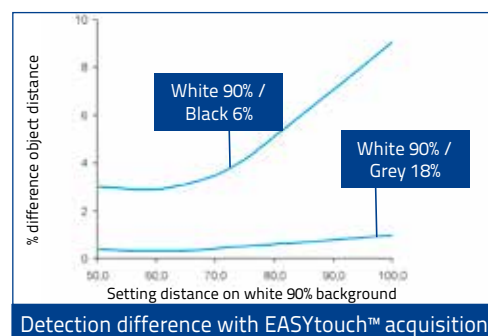

S60...W08

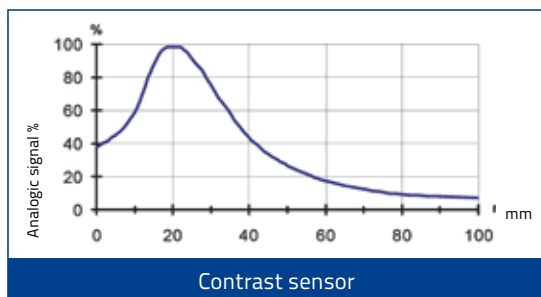

Contrast sensor

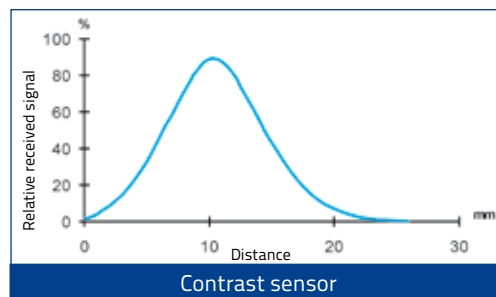

Contrast sensor

S60...U08

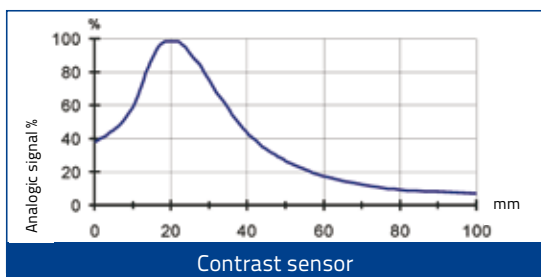

Contrast sensor

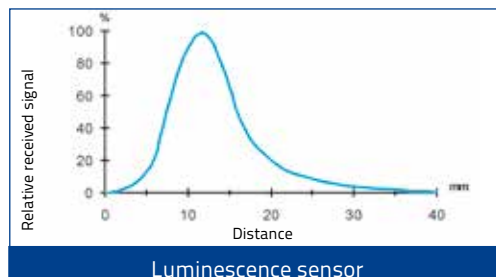

Luminescence sensor

MODEL SELECTION AND ORDER INFORMATION

MODEL	FUNCTION	N° ORDER
S60-PA-2-B01-NN	polarized retroreflective	956201460
S60-PA-2-B01-PP	polarized retroreflective	956201300
S60-PA-2-C01-NN	diffuse proximity	956201470
S60-PA-2-C01-PP	diffuse proximity	956201310
S60-PA-2-C11-NN	long diffuse proximity	956201480
S60-PA-2-C11-PP	long diffuse proximity	956201320
S60-PA-2-F01-NN	receiver	956201490
S60-PA-2-F01-PP	receiver	956201330
S60-PA-2-G00-XG	emitter	956201340
S60-PA-2-T51-NN	retroreflective for transparents	956201530
S60-PA-2-T51-PP	retroreflective for transparents	956201380
S60-PA-2-U08-NH	luminescence sensor	956201540
S60-PA-2-U08-PH	luminescence sensor	956201390
S60-PA-2-W08-NH	contrast sensor	956201550
S60-PA-2-W08-PH	contrast sensor	956201400
S60-PA-5-B01-NN	polarized retroreflective	956201180
S60-PA-5-B01-PP	polarized retroreflective	956201040
S60-PA-5-B51-NN	coaxial polarized retroreflective	956201630
S60-PA-5-B51-PP	coaxial polarized retroreflective	956201620
S60-PA-5-C01-NN	diffuse proximity	956201190
S60-PA-5-C01-PP	diffuse proximity	956201050
S60-PA-5-C11-NN	long diffuse proximity	956201200
S60-PA-5-C11-PP	long diffuse proximity	956201110
S60-PA-5-F01-NN	receiver	956201210
S50-PA-5-F01-PP	receiver	956201060
S60-PA-5-G00-XG	emitter	956201070
S60-PA-5-M08-NH	background suppression	956201220
S60-PA-5-M08-PH	background suppression	956201080

MODEL	FUNCTION	N° ORDER
S60-PA-5-T51-NN	retroreflective for transparents	956201250
S60-PA-5-T51-PP	retroreflective for transparents	956201100
S60-PA-5-U08-NH	luminescence sensor	956201010
S60-PA-5-U08-PH	luminescence sensor	956201000
S60-PA-5-W08-NH	contrast sensor	956201030
S60-PA-5-W08-PH	contrast sensor	956201020
S60-PL-2-B01-NN	laser polarized retroreflective	956201560
S60-PL-2-B01-PP	laser polarized retroreflective	956201410
S60-PL-2-C01-NN	laser diffuse proximity	956201640
S60-PL-2-C01-PP	laser diffuse proximity	956201650
S60-PL-2-F01-NN	laser receiver	956201570
S60-PL-2-F01-PP	laser receiver	956201420
S60-PL-2-G00-XG	laser emitter	956201430
S60-PL-2-M08-NH	laser background suppression	956201580
S60-PL-2-M08-PH	laser background suppression	956201440
S60-PL-5-B01-NN	laser polarized retroreflective	956201260
S60-PL-5-B01-PP	laser polarized retroreflective	956201120
S60-PL-5-C01-NN	laser diffuse proximity	956201660
S60-PL-5-C01-PP	laser diffuse proximity	956201670
S60-PL-5-F01-NN	laser receiver	956201270
S50-PL-5-F01-PP	laser receiver	956201140
S60-PL-5-G00-XG	laser emitter	956201150
S60-PL-5-M08-NH	laser background suppression	956201280
S60-PL-5-M08-PH	laser background suppression	956201160

ACCESSORIES

The series is compatible with the following Datalogic Automation accessories

- CS connectors
- R reflectors

New accessories dedicated to the S60 series have been developed to cover all the fixing requirements and improve functioning.

ACCESSORY SELECTION AND ORDER INFORMATION

MODEL	DESCRIPTION	ORDER N°
ST-5018	protection bracket	95ACC5310
ST-5019	protection bracket	95ACC5320
ST-5020	fixing bracket	95ACC5330
ST-5021	fixing bracket	95ACC5340
JOINT-60	protection bracket with jointed support	95ACC5350
ST-504	S6/S60 fixing bracket	95ACC2820

ACCESSORIES DIMENSIONS

ST-504

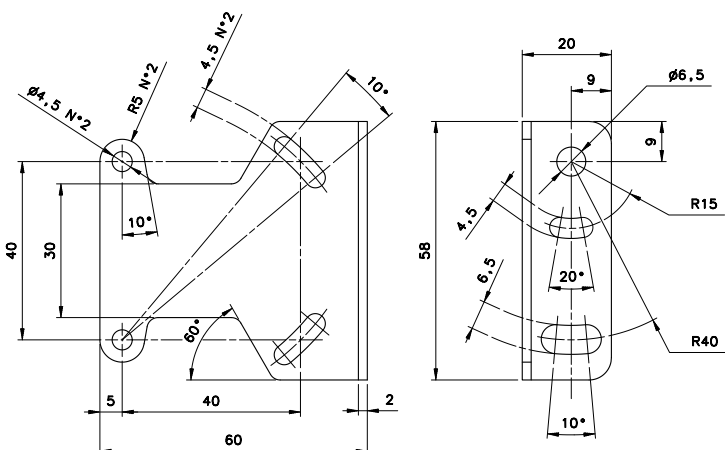

ST-5018

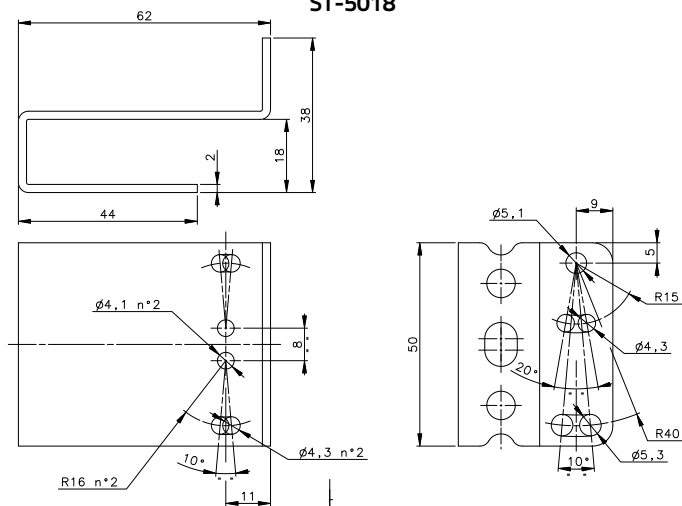

ST-5019

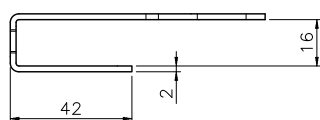
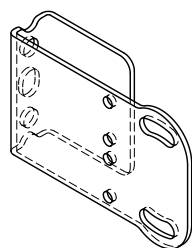

ST-5020

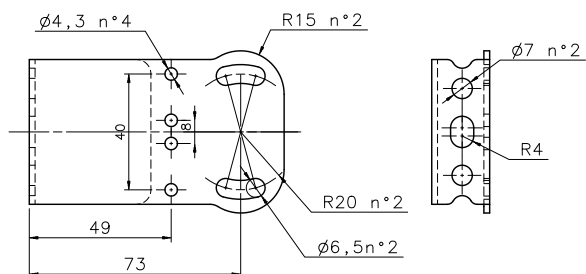
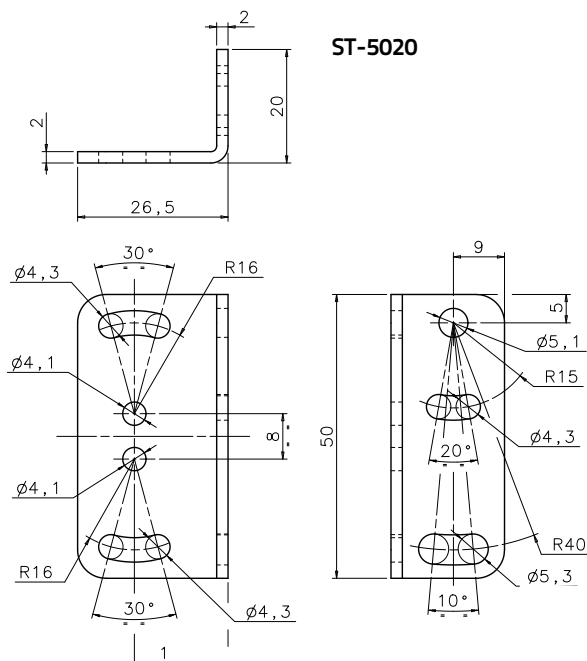

ST-5021

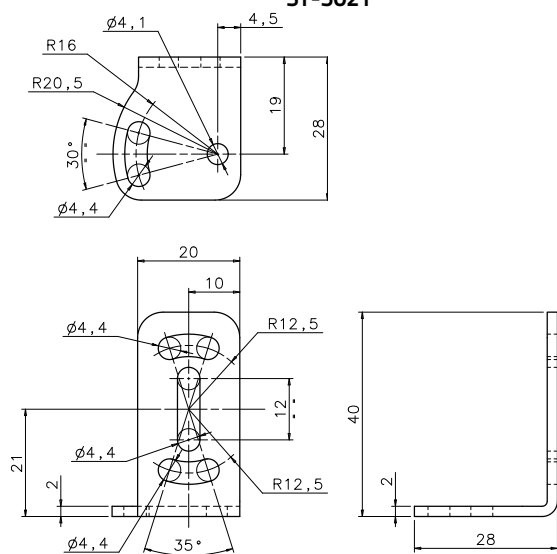

JOINT-60

