



S45

High Performance european style miniature sensor all-in-one family

- Red LED and Laser emissions
- Precise risk free laser class 1 emission
- Diffused LED proximity 800mm
- Background Suppression 400mm
- Retroreflective Class 1 Laser 15m/Red LED 7m
- Through beam Class 1 Laser 20m/Red LED 15m
- IP69K housing
- 2m Cable or metal M8 4 pole version
- PNP or NPN output with remote teach in input
- High speed RGB and white emission contrast sensor
- High precision distance sensor up to 200 mm



SENSORS

APPLICATIONS

- Processing and Packaging machinery
- Cosmetic and Pharmaceutical industry
- Electronics assembling
- Conveyor lines, material handling
- Automotive industry
- Print and paper industry
- Small part detection with maximum accuracy



S45		
Through beam		20m. (Laser Class1) 15m. (Red Led)
Polarized Retroreflective		15m. (Laser Class1) 7m. (Red Led)
Autocollimated Retroreflective for Transparent objects		2m. (Red Led)
Autocollimated Retroreflective		2m. (Red Led)
Diffused proximty		250mm. (Laser Class1) 800mm. (Red Led)
Background suppressor		120mm. (Laser Class 1) 200mm. (Red Led) 400mm. (Red Led)
Distance sensor		80mm. (Red Led) 200mm. (Red Led)
Contrast Sensor		12mm. (White) 12mm. (RGB)
Pwer Supply	Vdc	10...30Vdc
	Vac	(13...30Vdc Y models)
	Vac/Vdc	
Output	PNP	▪
	NPN	▪
	NPN/PNP	
	relay	
	other	Push Pull (Wxx, Yxx), Analog 0...10 V (Yxx)
Connection	cable	▪
	connector	▪
	pig-tail	
Approximate dimensions (mm)		34mm. x 20mm. X 12mm.
Housing material		ABS(Housing), PMMA (Optics)
Mechanical protection		IP67 & IP69K

TECHNICAL DATA	
Power supply	10...30Vdc (13...30Vdc Y models)
Ripple	10% max.
Consumption (Load current excluded)	≤ 30 mA
Light emission Setting	Red LED 632 nm, Red Laser 650 nm Push Button TEACH-IN
Indicators	LED Green Operating Voltage LED Yellow Output Status
Output	NPN, PNP, Push Pull
Output current	100 mA
Saturation voltage	2 V max
Response time	500 μs 333 μs (C03 Laser) 250 μs (F/G Laser) 50 μs (W03, W33) 20 μs (W13, W43)
Switching frequency	≤ 1000Hz ≤ 1500Hz (C03 Laser) ≤ 2000 Hz (F/G Laser) ≤ 10 kHz (W03, W33) ≤ 25 kHz (W13, W43)
Connection	Plastic M8 4-pole connector, Metal M8 4-pole connector 2 m cable
Dielectric strength	500 Vac, 1min between electronic and housing
Insulating resistance	>20M OHM, 500 Vdc between electronic and housing
Electrical protection	class 2
Mechanical protection	IP67 & IP69K
Ambient light rejection	according to EN 60947-5-2
Vibrations	0,5mm amplitude, 10...55Hz frequency, for every axis (EN60068-2-6)
Shock resistance	11 ms (30G) 6 shock for every axis (EN60068-2-27)
Housing material	ABS
Lens material	PMMA
Operating temperature	-20...+60 °C
Storage temperature	-20...+80 °C
Weight	10g. with connector, 40g. with cable

DIMENSIONS

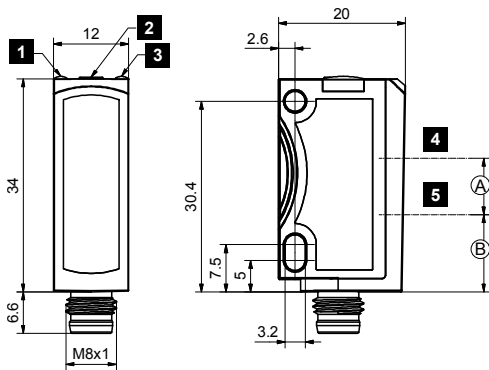

	S45-PR-2(5)-M03 S45-PR-5-Y03	S45-PR-2(5)-M13 S45-PR-5-Y13	S45-PR-2(5)-C03 S45-PR-B03	S45-PH-5-M03	S45-PH-5-C03 S45-PH-B03	S45-PR-G00	S45-PH-G00	S45-PR(PH)-F03
A	9	11.75	10.8	8.8	8.8	11.5	13.5	
B	12.3	11	11.5	12.5	13.5			22.3

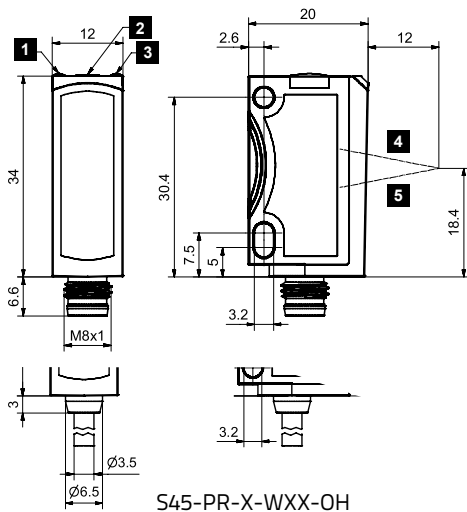

S45-PR-X-WXX-OH

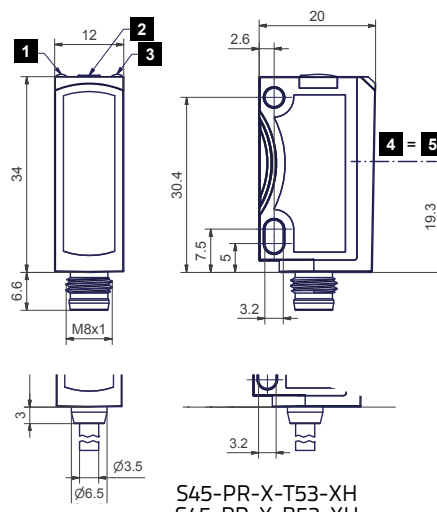

S45-PR-X-T53-XH
S45-PR-X-B53-XH

1	Yellow LED 1)
2	Button
3	Green LED 2)
4	Receiver axis
5	Emitter axis

- 1) switching output indicator
2) operating voltage indicator

CONNECTIONS

CABLE

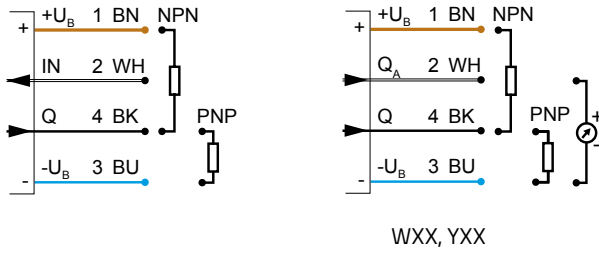

M8 CONNECTOR

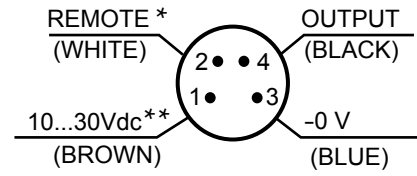

* Analog out YXX

** 13...30Vdc Y models

INDICATORS AND SETTINGS

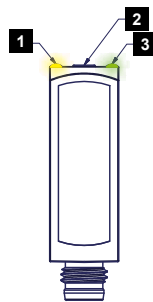

1	Yellow LED 1)
2	Button
3	Green LED 2)

- 1) switching output indicator
- 2) operating voltage indicator

DETECTION DIAGRAMS

BACKGROUND SUPPRESSOR

DETECTION SPOT SIZE

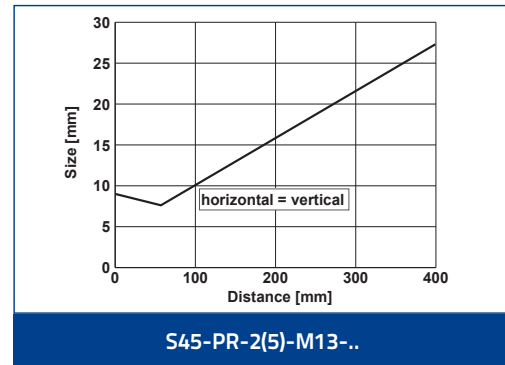
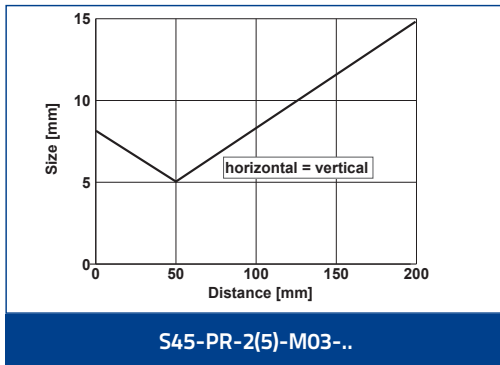

B/W SHIFT

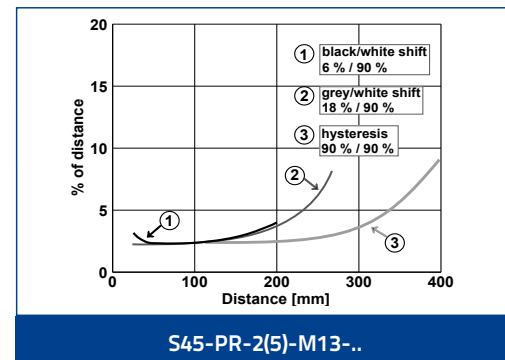
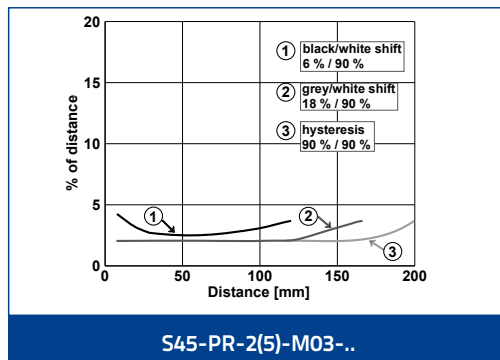

ENERGETIC DIFFUSED

DETECTION SPOT SIZE

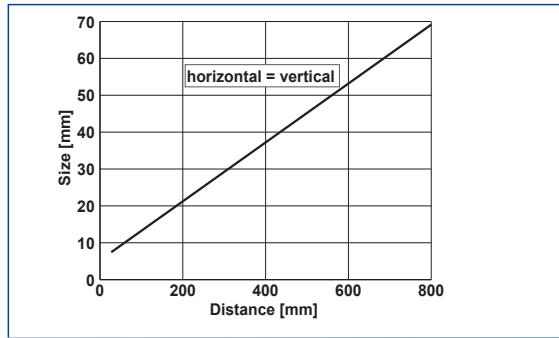

S45-PR-2(5)-C03-..

EXCESS GAIN

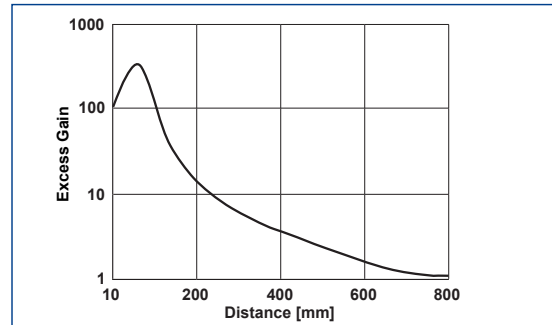

S45-PR-2(5)-C03-..

RETROREFLECTIVE POLARIZED

DETECTION SPOT SIZE

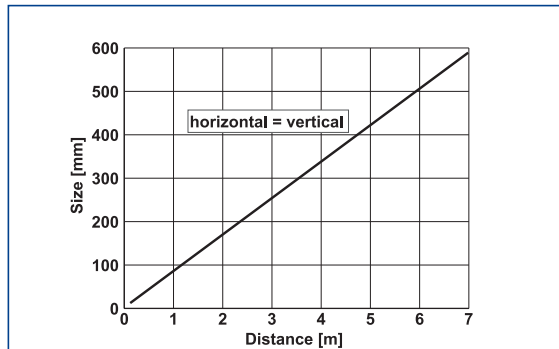

S45-PR-2(5)-B03-..

EXCESS GAIN

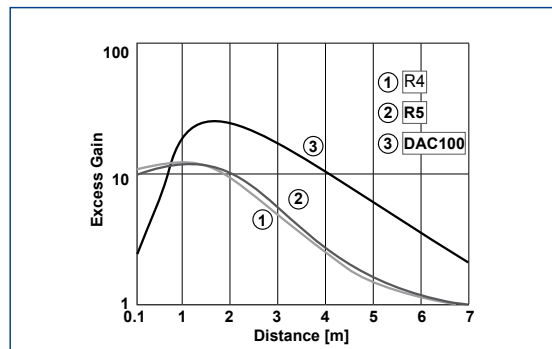

S45-PR-2(5)-B03-..

COAXIAL RETROREFLECTIVE POLARIZED

DETECTION SPOT SIZE

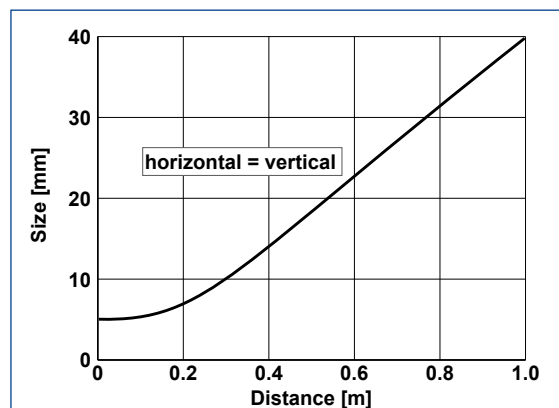

S45-PR-5-B53-..

RETROREFLECTIVE FOR TRANSPARENT

DETECTION SPOT SIZE

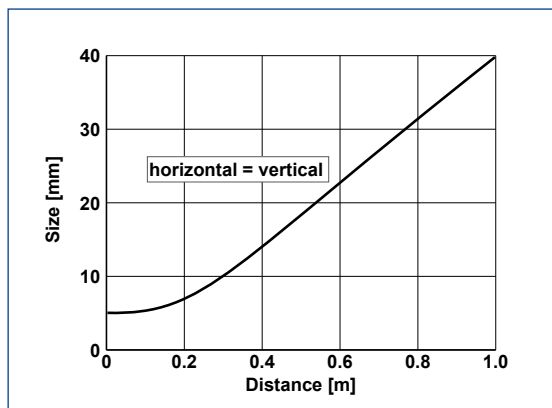

S45-PR-2(5)-T53-..

THROUGH BEAM

DETECTION SPOT SIZE

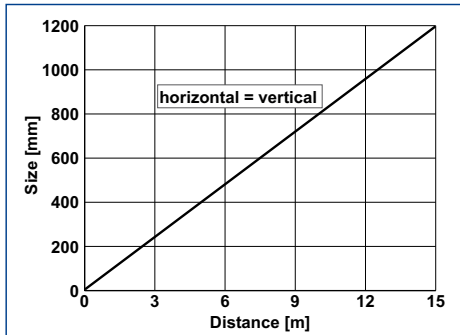

S45-PR-2(5)-F03-../S45-PR-2(5)-G00-XE

EXCESS GAIN

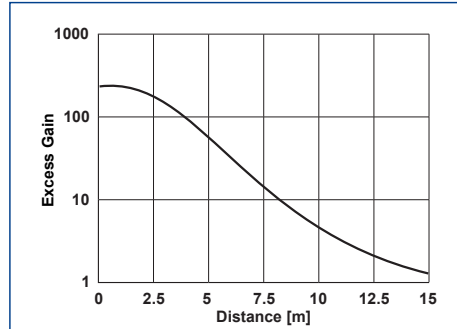

S45-PR-2(5)-F03-../S45-PR-2(5)-G00-XE

LASER BACKGROUND SUPPRESSOR

DETECTION SPOT SIZE

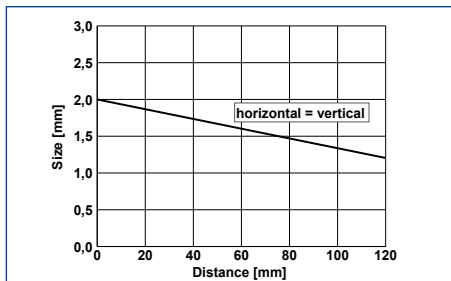

S45-PH-5-M03-..

B/W SHIFT

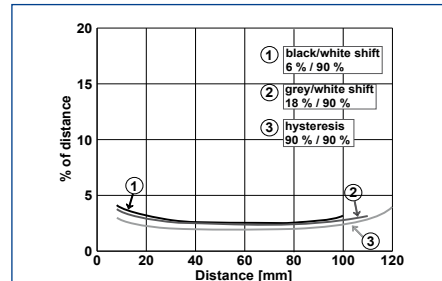

S45-PH-5-M03-..

LASER ENERGETIC DIFFUSED

DETECTION SPOT SIZE

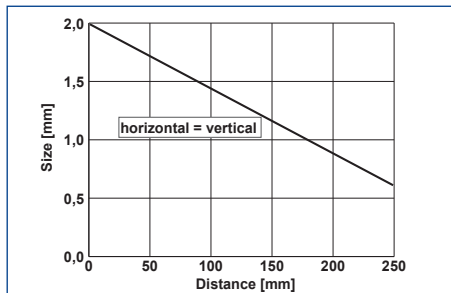

S45-PH-5-C03-..

EXCESS GAIN

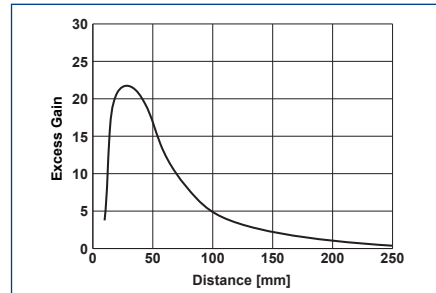

S45-PH-5-C03-..

LASER RETROREFLECTIVE POLARIZED

DETECTION SPOT SIZE

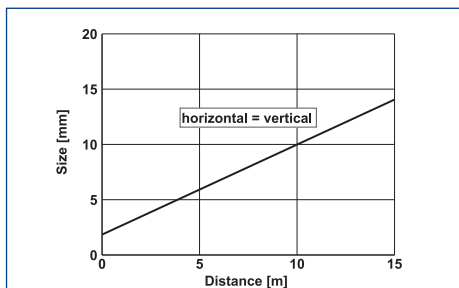

S45-PH-5-B03-..

EXCESS GAIN

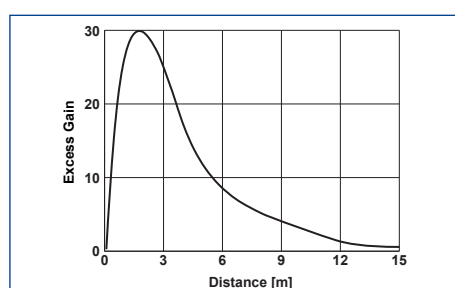

S45-PH-5-B03-..

LASER THROUGH BEAM

DETECTION SPOT SIZE

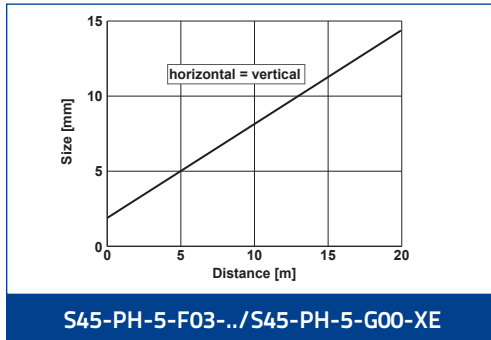

EXCESS GAIN

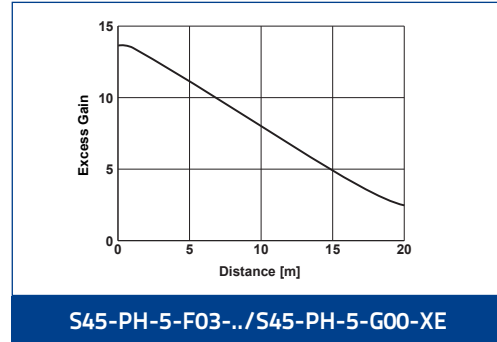

CONTRAST SENSOR

READING DIAGRAM

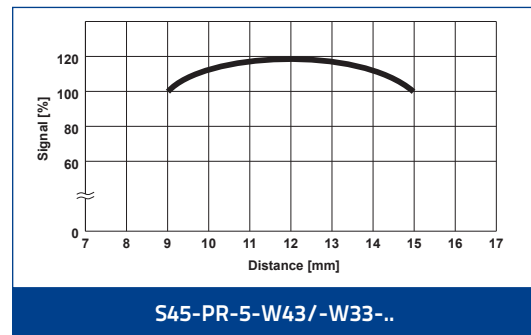
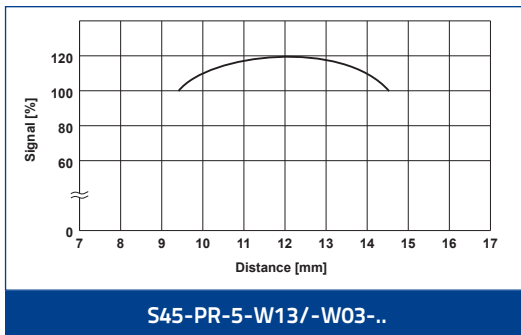

DISTANCE SENSOR

DETECTION SPOT SIZE

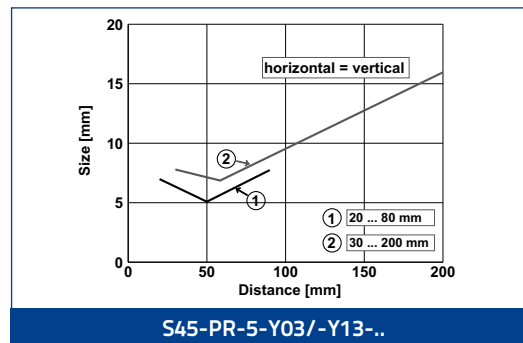

SCANNING PROPERTIES

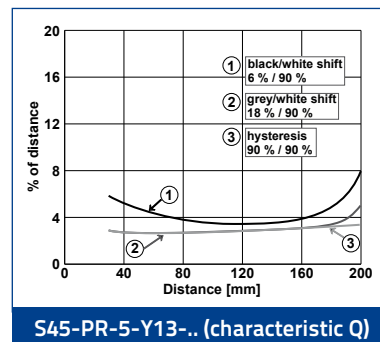
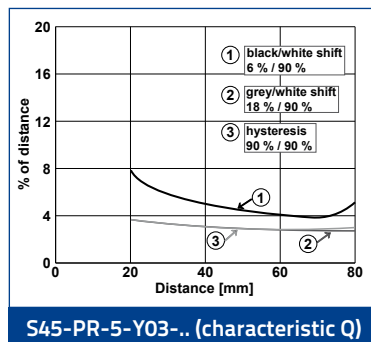

MODEL SELECTION AND ORDER INFORMATION

OPTIC FUNCTION	EMISSION	CONNECTION	OUTPUT	MODEL	ORDER NO.
Diffused proximity	LED	2m Cable	PNP	S45-PR-2-C03-PH	950411220
			NPN	S45-PR-2-C03-NH	950411210
		M8	PNP	S45-PR-5-C03-PH	950411240
			NPN	S45-PR-5-C03-NH	950411230
	LASER	M8	PNP	S45-PH-5-C03-PH	950411260
			NPN	S45-PH-5-C03-NH	950411250
Polarized Retroreflective	LED	2m Cable	PNP	S45-PR-2-B03-PH	950411100
			NPN	S45-PR-2-B03-NH	950411090
		M8	PNP	S45-PR-5-B03-PH	950411120
			NPN	S45-PR-5-B03-NH	950411110
	LASER	M8	PNP	S45-PH-5-B03-PH	950411140
			NPN	S45-PH-5-B03-NH	950411130
Polarized retroreflective autocollimated for transparent	LED	2m Cable	PNP	S45-PR-2-T53-PH	950411160
			NPN	S45-PR-2-T53-NH	950411150
		M8	PNP	S45-PR-5-T53-PH	950411180
			NPN	S45-PR-5-T53-NH	950411170
Polarized retroreflective autocollimated	LED	M8	PNP	S45-PR-5-B53-PH	950411200
			NPN	S45-PR-5-B53-NH	950411190
Through beam	LED	2m Cable	-	S45-PR-2-G00-XE	950411000
			PNP	S45-PR-2-F03-PH	950411020
			NPN	S45-PR-2-F03-NH	950411010
		M8	-	S45-PR-5-G00-XE	950411030
			PNP	S45-PR-5-F03-PH	950411050
			NPN	S45-PR-5-F03-NH	950411040
	LASER	M8	-	S45-PH-5-G00-XE	950411060
			PNP	S45-PH-5-F03-PH	950411080
			NPN	S45-PH-5-F03-NH	950411070
			PNP	S45-PR-2-M03-PH	950411280
Background suppressor 200mm	LED	2m Cable	NPN	S45-PR-2-M03-NH	950411270
			PNP	S45-PR-5-M03-PH	950411300
		M8	NPN	S45-PR-5-M03-NH	950411290
			PNP	S45-PR-2-M13-PH	950411320
Background suppressor 400mm	LED	2m Cable	NPN	S45-PR-2-M13-NH	950411310
			PNP	S45-PR-5-M13-PH	950411340
		M8	NPN	S45-PR-5-M13-NH	950411330
			PNP	S45-PH-5-M03-PH	950411360
Background suppressor laser	LASER	M8	NPN	S45-PH-5-M03-NH	950411350
			PNP	S45-PR-5-Y03-PV	950411380
Distance sensor	LED	M8	NPN	S45-PR-5-Y03-NV	950411370
			PNP	S45-PR-5-Y13-PV	950411400
Distance sensor	LED	M8	NPN	S45-PR-5-Y13-NV	950411390
			WHITE	M8	PUSH-PULL
Contrast Sensor 10kHz	RGB	M8	PUSH-PULL		S45-PR-5-W13-OH
	WHITE		M8	PUSH-PULL	S45-PR-5-W33-OH
Contrast Sensor 25kHz	RGB	M8		PUSH-PULL	S45-PR-5-W43-OH

ACCESSORIES

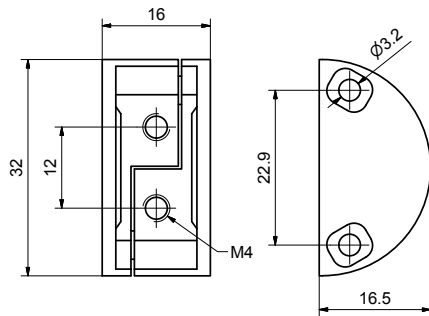

ST-S45-DVT

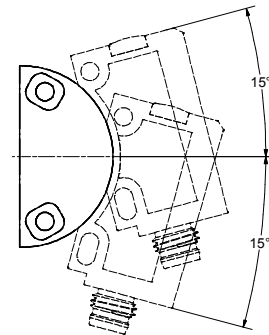

ST-S45-DVT

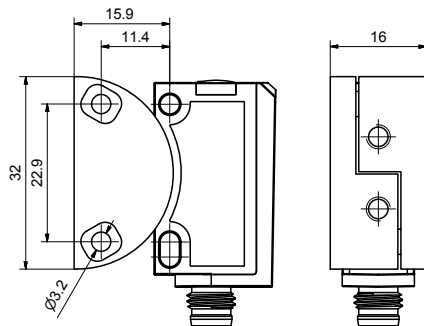

ST-S45-DVT

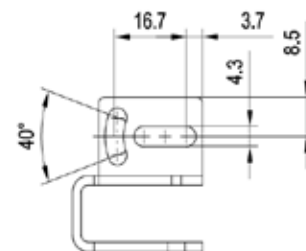
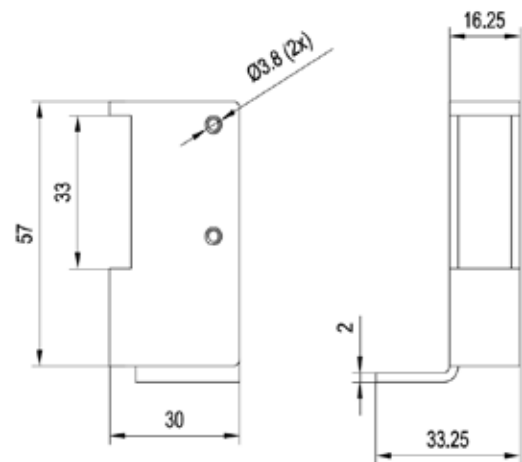

ST-MINI-PRO

MODEL	DESCRIPTION	ORDER NO.
ST-S45-DVT	S45 DOVE TAIL BRACKET	95ACC7970
ST-MINI-PRO	MINI PROTECTIVE BRACKET	95ACC7980

CABLES

TYPE	DESCRIPTION	LENGTH	MODEL	ORDER No.
Axial M8 Connector	4-pole, grey, P.V.C.	3 m	CS-B1-02-G-03	95A251420
		5 m	CS-B1-02-G-05	95A251430
		7 m	CS-B1-02-G-07	95A251440
		10 m	CS-B1-02-G-10	95A251480
	4-pole, P.U.R.	2 m	CS-B1-02-R-02	95A251620
		5 m	CS-B1-02-R-05	95A251640
Radial M8 Connector	4-pole, grey, P.V.C.	3 m	CS-B2-02-G-03	95A251450
		5 m	CS-B2-02-G-05	95A251460
		7 m	CS-B2-02-G-07	95A251470
		10 m	CS-B2-02-G-10	95A251530
	4-pole, P.U.R.	2 m	CS-B2-02-R-02	95A251630
		5 m	CS-B2-02-R-05	95A251650